

# ELECRAFT®

## W2 WATTMETER



## OWNER'S MANUAL

Revision B, November 19, 2009

Copyright © 2009, Elecraft, Inc.

All Rights Reserved

# Contents

Introduction.....	3
Customer Service and Support .....	3
Technical Assistance.....	3
Repair / Alignment Service .....	3
Specifications.....	4
Display Unit.....	4
Directional Couplers (Sensors) .....	4
Operation .....	5
Front Panel .....	5
Rear Panel .....	6
Directional Coupler (Sensor) .....	7
Computer Interface.....	7
Firmware Updates .....	7
SWR Alarm Function.....	8
Kit Assembly .....	8
Preventing Electrostatic Discharge Damage .....	8
Tools Required .....	9
Assembly Procedure.....	9
Display Unit Assembly .....	9
Directional Coupler.....	16
Appendix A Parts List .....	17
W2 Circuit Boards.....	17
Enclosure.....	17
W2 Hardware (E850356) .....	18
Cables.....	19
Sensors .....	19
Appendix B – Schematic Diagrams.....	20

# Introduction

The Elecraft W2 is a versatile, auto-ranging RF power and SWR meter that utilizes remote sensing. Up to two remote sensors can be attached, with various power and frequency ranges available (see Sensors, page 19). Sensors use standard CAT5 shielded or unshielded cables.

The W2 includes adjustable, high-brightness LED bargraphs for both forward power and SWR. These allow you to keep track of transmitter or amplifier performance at a glance, even in low lighting or across a large room. The power bargraph's full scale ranges are 2, 20, 200, and 2000 watts, with either manual or automatic range selection or peak- hold capability.

A PC-compatible serial interface is included, allowing easy firmware upgrading via the internet, as well as configuration of the W2's advanced features. The serial interface cable can be connected directly to any RS232 port, or be used with our "KUSB" USB-to-RS232 adapter. Software applications can use the serial interface to accurately read forward power, reverse power, and SWR from both sensors. This is ideal for remote control as well as customized meter displays.

Also provided is a general purpose alarm output (open-drain) and amplifier keying input/output jacks. The latter can be used to interrupt amplifier keying on power or SWR alarm conditions.

Subsequent sections provide full specifications, operating information, and assembly instructions for building the no-soldering kit version of the W2.

## Customer Service and Support

### *Technical Assistance*

You can send e-mail to [support@elecraft.com](mailto:support@elecraft.com) and we will respond quickly - typically the same day Monday through Friday. Telephone assistance is available from 9 A.M. to 5 P.M. Pacific time (weekdays only) at 831-763-4211. Please use e-mail rather than calling when possible since this gives us a written record of the details of your problem and allows us to handle a larger number of requests each day.

### *Repair / Alignment Service (We want to make sure everyone succeeds!)*

If necessary, you may return your Elecraft product to us for repair or alignment. (Note: We offer unlimited email and phone support to get your kit running, so please try that route first as we can usually help you find the problem quickly.)

**IMPORTANT: You must contact Elecraft before mailing your product** to obtain authorization for the return, what address to ship it to and current information on repair fees and turnaround times. (Frequently we can determine the cause of your problem and save you the trouble of shipping it back to us.) Our repair location is different from our factory location in Aptos. We will give you the address to ship your kit to at the time of repair authorization. *Packages shipped to Aptos without authorization will incur an additional shipping charge for reshipment from Aptos to our repair depot.*

## Elecraft's 1-Year Limited Warranty

This warranty is effective as of the date of first consumer purchase (or if shipped from factory, date product is shipped to customer). It covers both our kits and fully assembled products. For kits, before requesting warranty service, you should fully complete the assembly, carefully following all instructions in the manual.

**Who is covered:** This warranty covers the original owner of the Elecraft product as disclosed to Elecraft at the time of order. Elecraft products transferred by the purchaser to a third party, either by sale, gift or other method, who is not disclosed to Elecraft at the time of original order, are not covered by this warranty. If the Elecraft product is being bought indirectly for a third party, the third party's name and address must be provided to Elecraft at time of order to insure warranty coverage.

**What is covered:** During the first year after date of purchase, Elecraft will replace defective or missing parts free of charge (post-paid). We will also correct any malfunction to kits or assembled units caused by defective parts and materials. Purchaser pays inbound shipping to Elecraft for warranty repair, Elecraft will pay shipping to return the repaired equipment to you by UPS ground service or equivalent to the continental USA and Canada. Alaska, Hawaii and outside U.S. and Canada actual return shipping cost paid by owner.

**What is not covered:** This warranty does not cover correction of kit assembly errors. It also does not cover misalignment; repair of damage caused by misuse, negligence, or builder modifications; or any performance malfunctions involving non-Elecraft accessory equipment. The use of acid-core solder, water-soluble flux solder, or any corrosive or conductive flux or solvent will void this warranty in its entirety. Also not covered is reimbursement for loss of use, inconvenience, customer assembly or alignment time, or cost of unauthorized service.

**Limitation of incidental or consequential damages:** This warranty does not extend to non-Elecraft equipment or components used in conjunction with our products. Any such repair or replacement is the responsibility of the customer. Elecraft will not be liable for any special, indirect, incidental or consequential damages, including but not limited to any loss of business or profits.

## Specifications

### Display Unit

Size (H x W x D)	1.8" x 6.1" x 4.5" (4.6 cm x 15.5 cm x 11.4 cm), not including connectors. 5.1" (13 cm) deep including connectors, LEDs, rear panel brightness control.
Weight	11.7 oz. (0.33 kg)
Supply voltage	9-16 VDC maximum (10-15 VDC recommended)
Current drain	50 mA idle, 650 mA max, 300 mA typical

### Directional Couplers (Sensors)<sup>1</sup>

Size (H x W x D)	2.5" x 2.3" x 5.0" (6.4 cm x 5.8 cm x 12.7 cm), not including connectors.
Weight	7.5 oz. (0.21 kg) typical
Power Range:	(200W Sensor) 0-2W, 0-20W, 0-200W, Auto (2 KW sensor) 0-20W, 0-200W, 0-2000W, Auto
Accuracy:	+/- 0.5 dB typical
Frequency Range:	(HF Sensors) 1.8 - 54 MHz (VHF Sensors) 144 - 450 MHz
Sensor Cable:	5'6" (168 cm) 8-conductor Ethernet (CAT 5) with RJ45 connectors.

<sup>1</sup> One Sensor is required. Two may be connected to the display unit at the same time.

# Operation

Typically the W2 is inserted between the transmitter and an antenna tuner, if one is used. The W2 then displays the SWR presented to the transmitter. If the W2 is inserted between the antenna tuner and antenna, it will show the antenna's unmatched SWR. The power reading may be less accurate when the unmatched SWR is high.

The purpose and operation of each control and indicator on the front panel is described below. On the next page the rear panel is shown with descriptions of the cable connections and functions of each connector and control.

## Front Panel

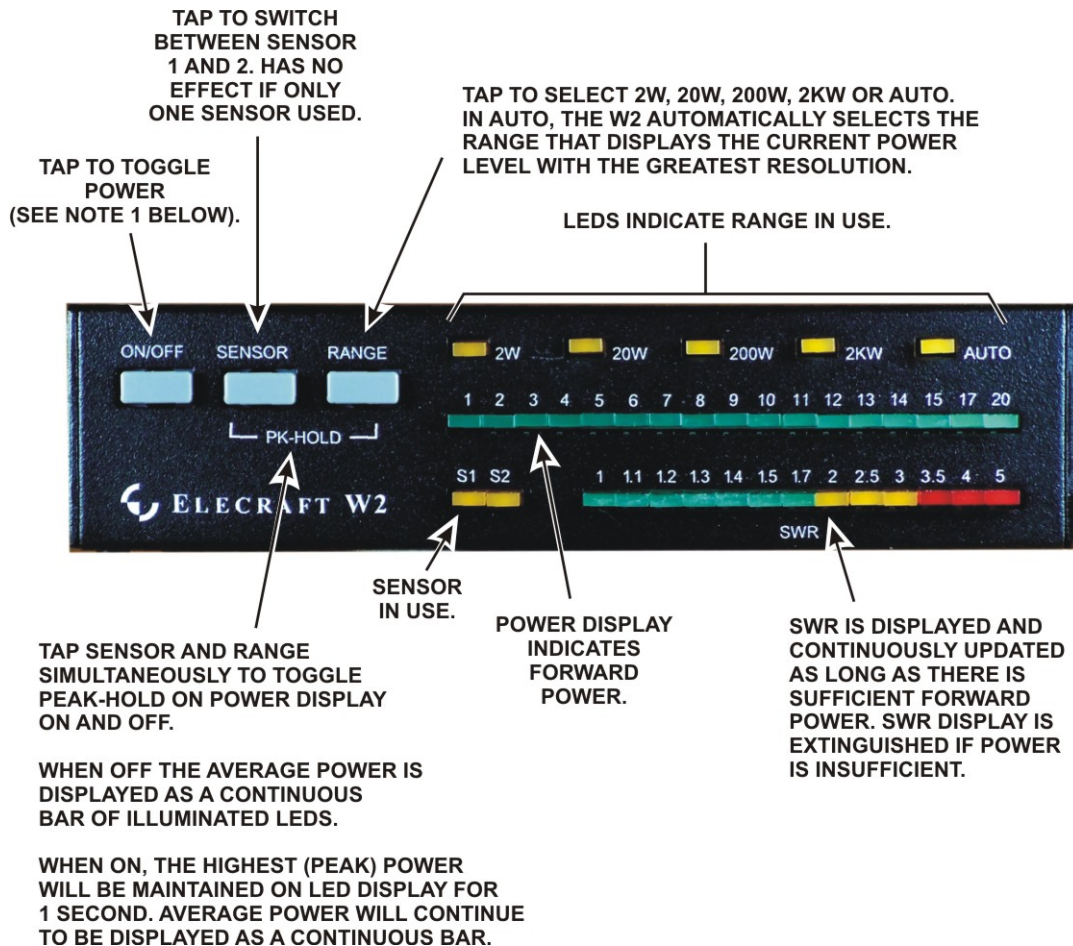

### IMPORTANT NOTES:

1. An automated power-on test cycles all of the front panel LEDs on and off when the POWER button is pressed. Also, the PTT RY (see Note 3 on the next page) cycles; you can hear it click in a quiet environment.
2. If the Alarm function is set, all the front panel LEDs will flash if the SWR exceeds 3:1 until you reset the W2 by pressing either the SENSOR or the RANGE button. See *SWR Alarm Function* on page 8.
3. The SENSOR, RANGE and PK HOLD settings you select are automatically reinstated after the power has been turned off.
4. The power display is not affected by the SWR.

## Rear Panel

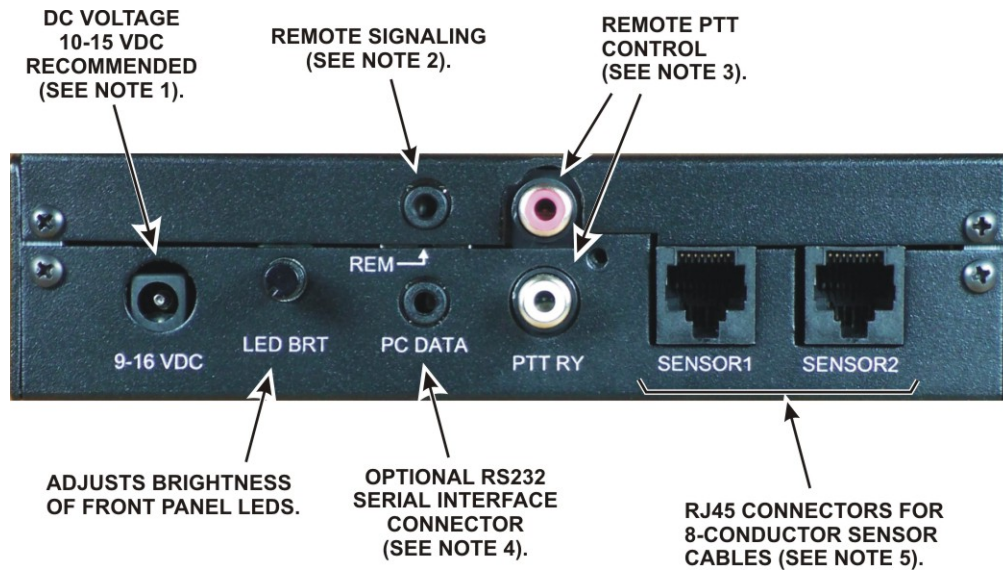

### REAR PANEL CONNECTOR NOTES:

1. A power cable is provided with your W2 with a mating connector for the W2 at one end and tinned leads for connecting to a power supply at the other end. An RCA plug is also supplied that you may connect to use the 12VDC accessory output on the back panel of the K3.
2. Remote Signaling Connector: Provides an alarm output, dropping from +5V to ground when the SWR exceeds 3:1 (see note 3 below) on the connector ring. Connector tip is a logic (0-5V) input provided for possible future use.
3. Remote PTT Control: Relay switched loop-through provided to disable a transmitter or exciter for high SWR protection if the SWR Alarm is set (see *SWR Alarm Function* on page 8).
4. PC Data (Optional): Provides an RS232 data interface that may be used to connect the W2 to a personal computer. See *Computer Interface* on page 7 and Appendix B for details.
5. Sensor 1 and 2: A suitable cable is provided with each Sensor unit to connect it to the display.

## Directional Coupler (Sensor)

A directional coupler is used to measure RF power and standing wave ratio (SWR). A typical directional coupler is shown below. At least one sensor must be connected to the W2.

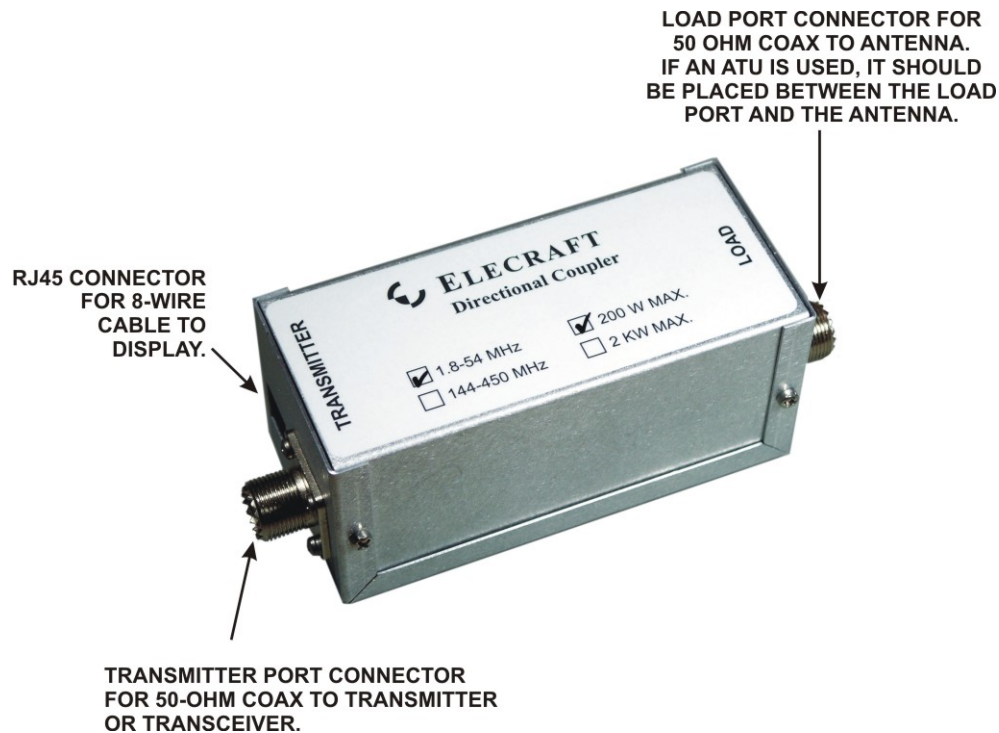

## Computer Interface

The computer interface provides access to advanced functions controlled through your personal computer (PC). You'll need a computer with an RS232 interface or a USB interface and a USB to RS232 converter such as the KUSB universal serial bus adapter available from Elecraft. A suitable interface cable is included to connect your computer to the W2. The W2 Utility program for your computer may be downloaded free from [www.elecraft.com](http://www.elecraft.com).

### *Firmware Updates*

From time to time, updated and improved firmware may become available for the W2. The latest firmware may be downloaded from Elecraft and installed using the optional PC interface and the W2 Utility program. Updated program files may be obtained in two ways. You can check the box in the W2 Utility that says "Copy new files from Elecraft into local folder". This will download the latest production released firmware. Optionally, you can download the new file from the Elecraft web site manually and place it in a local folder, then browse for it within the W2 utility. This is the way to access the latest Beta firmware available from Elecraft.

A new firmware load is initiated by turning the W2 off, then holding the SENSOR button depressed while pressing POWER to turn the W2 on. The green **1** LED on the power bar graph will blink indicating the W2 is ready for new firmware.

When you start loading new firmware, the green **1** LED on the power bar graph will turn off and the yellow **2W** LED will start flashing as new data is received. If the **2W** LED stays on but doesn't flash, data is not being received by the W2.

## *SWR Alarm Function*

If set, the SWR Alarm will cause all the LEDs to flash in unison if the SWR exceeds 3:1 and triggers the relay that opens the circuit between the center pins of the PTT RY phono connectors. The SWR Alarm function must be enabled each time the W2 power is turned on.

Send an ASCII character **a** to the W2 to toggle the alarm on or off. This may be done using the W2 Utility program Command Tester screen. The W2 will respond with **a1**; indicating the alarm is set or **a0**; indicating the alarm is disabled. If an alarm occurs, reset the W2 by pressing either the SENSOR or RANGE buttons.

## Kit Assembly

### Preventing Electrostatic Discharge Damage

Sensitive components in your W2 are may be damaged by Electrostatic Discharge (ESD) in any location or climate unless you take specific steps to prevent such damage. Many components can be damaged by static discharges of only a few volts: far too little for you to notice.

ESD damage may not be apparent at first. The damaged components may not fail completely. Instead, the damage may result in below-normal performance for an extended period of time before you experience a total failure.

We strongly recommend you take the following anti-static precautions (listed in order of importance) to ensure there is no voltage difference between the components and any object that touches them:

- Leave ESD-sensitive parts in their anti-static packaging until you install them. The packaging may be a special plastic bag that allow static charges to flow harmlessly over their surface, or the component's leads may be inserted in conductive foam that keep them at the same potential. Parts which are especially ESD-sensitive are identified in the parts list and in the assembly procedures.
- Wear a conductive wrist strap with a series 1-megohm resistor that will constantly drain off any static charge that accumulates on your body. If you do not have a wrist strap, touch a ground briefly before touching any sensitive parts to discharge your body. Do this frequently while you are working. You can collect a destructive static charge on your body just sitting at the work bench.

### **WARNING**

**DO NOT attach a ground directly to yourself without a current-limiting resistor as this poses a serious shock hazard. A wrist strap must include a 1-megohm resistor to limit the current flow. If you choose to touch an unpainted, metal ground to discharge yourself, do it only when you are not touching any live circuits with any part of your body.**

- Use a grounded anti-static mat on your work bench.
- If you choose to use a soldering iron to work on your W2 for any reason, be sure your iron has an ESD-safe grounded tip tied to the same common ground used by your mat or wrist strap.



## Tools Required

1. #0 and #1 size Phillips screwdrivers. Use the screwdriver that best fits the screw in each step. To avoid damaging screws and nuts, a power screwdriver is *not* recommended.
2. Needle-nose pliers.

The following tools are strongly recommended:

1. ESD wrist strap.
2. Static dissipating work pad.

## Assembly Procedure

Before starting construction, do a complete inventory, comparing the parts in your kit with the parts list in Appendix A, to familiarize yourself with all of the parts and to ensure the kit is complete.. If any parts are missing contact Elecraft for a replacement (see *Customer Service and Support*, page 3).

### Display Unit Assembly

Mount two standoffs and two 2D fasteners on the bottom of the main board as shown in Figure 1.

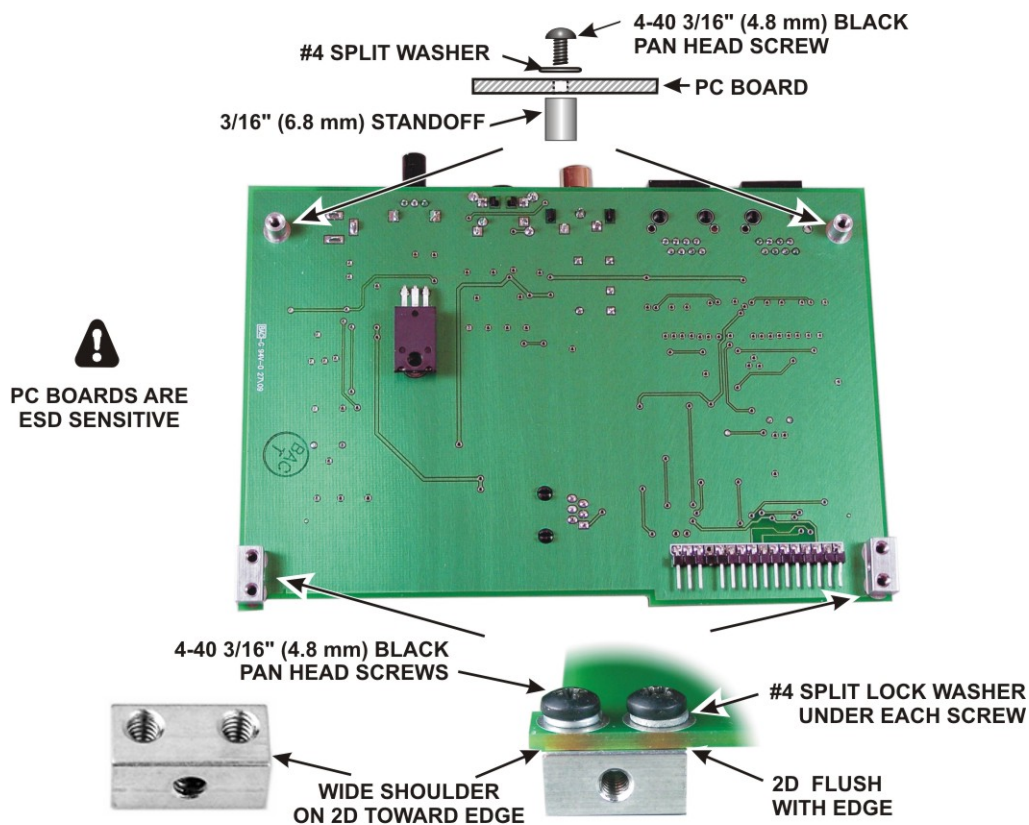

Figure 1. Installing Hardware on Main Board.

□ Place the 1/8" (2.9 mm) spacer under regulator U3 and temporarily secure it as shown in Figure 2. It is important that the spacer stay in place so it won't fall out later when you remove the screw to mount the bottom cover.

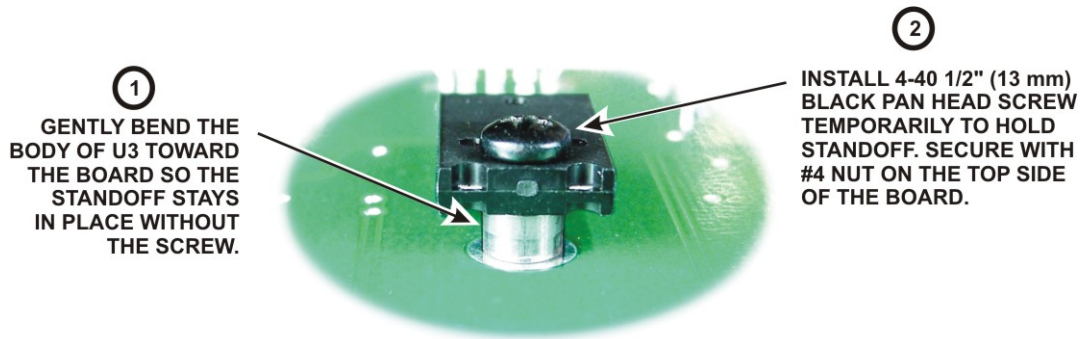

Figure 2. Installing U3 Spacer.

□ Locate the display board assembly. **Handle the assembly carefully to avoid misaligning the LED's** Check the front panel board for a nylon screw at the two corners with its head toward the rear (side opposite the LEDs) as shown in Figure 3. If necessary install a 2-56 5/32" (4.0 mm) nylon screw at each location. These screws are inserted until the heads just touch the PC board. They don't hold anything. When the W2 is fully assembled, the heads of these screws serve as "bumpers" that press against 2D fasteners in the case to keep the front panel board from flexing when buttons are pressed.

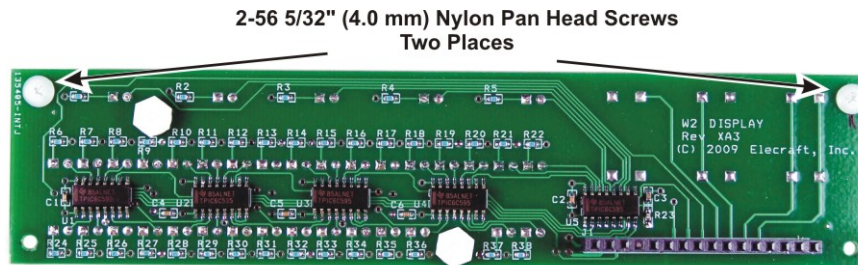

Figure 3. Nylon "Bumper" Screws in Front Panel Board.

□ Press one gray keycap onto each of the three pushbuttons on the front panel board (see Figure 4)

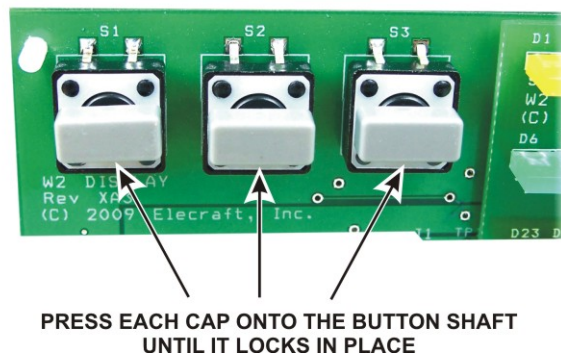

Figure 4. Installing Pushbutton Key Caps.

☐ Mate plug P1 on the bottom of the main board with jack J1 on the front panel board as shown in Figure 5. Note that one pin on P1 has been removed and a plug is placed in the corresponding hole in J1. This is to help avoid misaligning the connectors. Be sure the connectors are aligned and fully mated as shown.

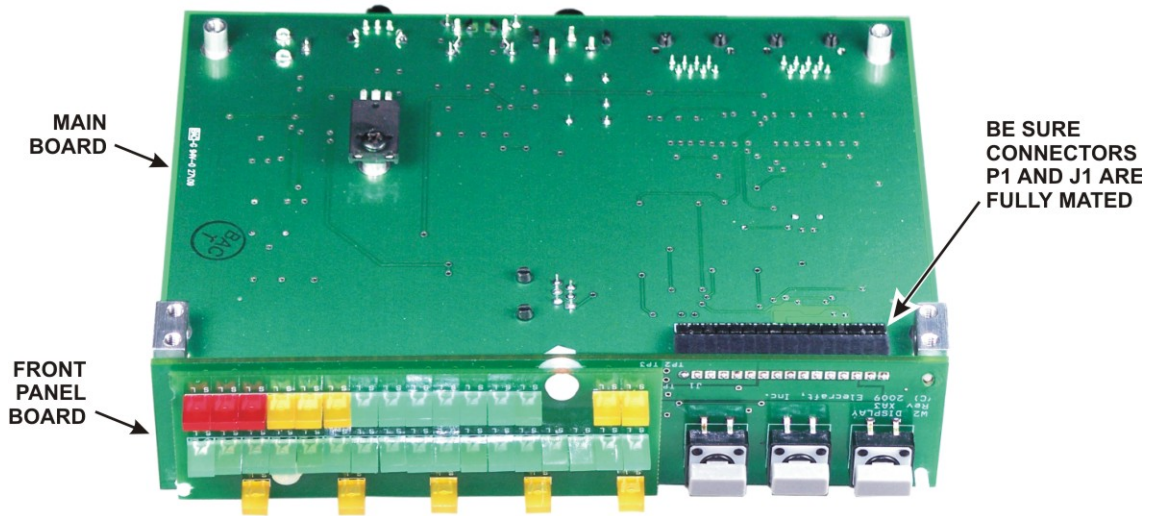

Figure 5. Mating the Front Panel and Main PC Boards.

☐ Locate the bottom cover and remove the paint from the inside around the corner screw holes as shown in Figure 6 so the cover will form good electrical contact with the standoffs and 2D fasteners when it is mounted.

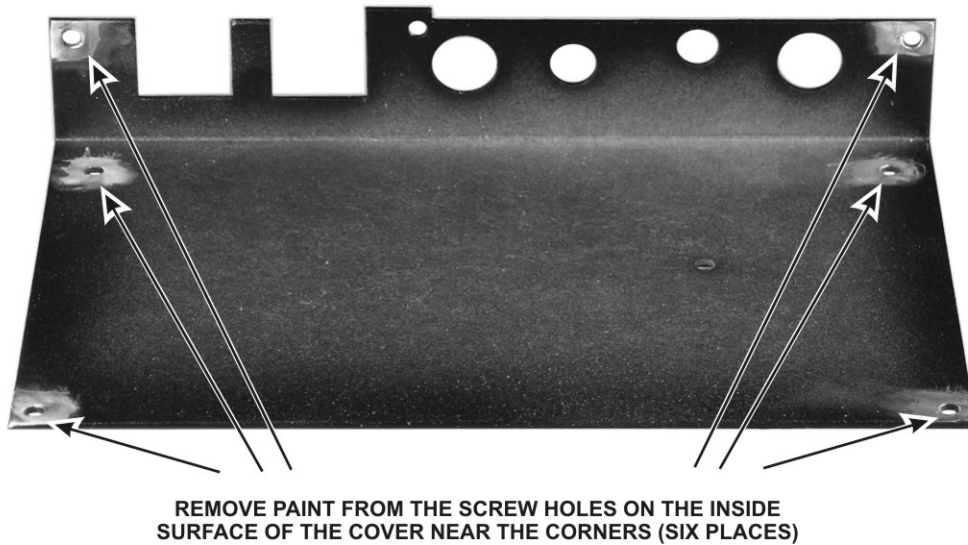
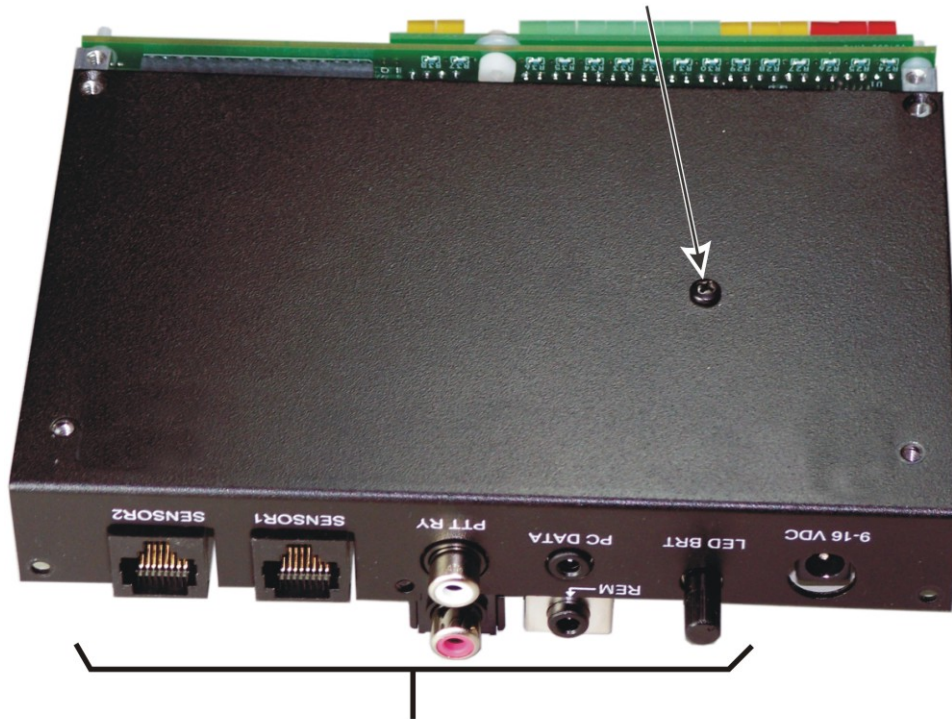

Figure 6. Preparing the Bottom Cover for Mounting.

Remove the screw holding the spacer between U3 and the pc board and mount the bottom cover as shown in Figure 7. Be careful not to dislodge the spacer. If it falls out, you must remove the cover and replace it as shown in Figure 2.

② REPLACE THE SCREW THROUGH THE BOTTOM COVER AND U3. LOOK IN THROUGH THE END TO MAKE SURE THE SPACER IS STILL BETWEEN U3 AND THE PC BOARD, THEN SECURE THE SCREW WITH A SPLIT RING LOCK WASHER AND 4-40 NUT ON TOP OF THE PC BOARD.



① REMOVE THE SCREW YOU PLACED THROUGH U3 TO HOLD THE SPACER AND SLIDE THE BOTTOM COVER ON FROM THE REAR, FITTING THE LED BRIGHTNESS CONTROL AND CONNECTORS THROUGH THE OPENINGS IN THE COVER.

Figure 7. Mounting Bottom Cover.

### **⚠ CAUTION**

**Do not put stress on the pc boards when installing the screws in the following step.**

Secure the bottom cover with four 3/16" (4.0 mm) black pan head screws. No lock washers are used. **Note: It is best not to tighten the screws until the enclosure is fully assembled so the panels can move slightly as needed for best alignment. This is a good practice to follow when installing all of the outer case components.**

Install a 1/4" (6.4 mm) black pan head screw into the mounting hole for the PTT RY connector as shown in Figure 10. **Do not tighten this screw! It only threads into plastic. Stop turning when the head reaches the back panel.** Even though you don't tighten the screw, it provides critical support to keep the connector from flexing when connectors are inserted.

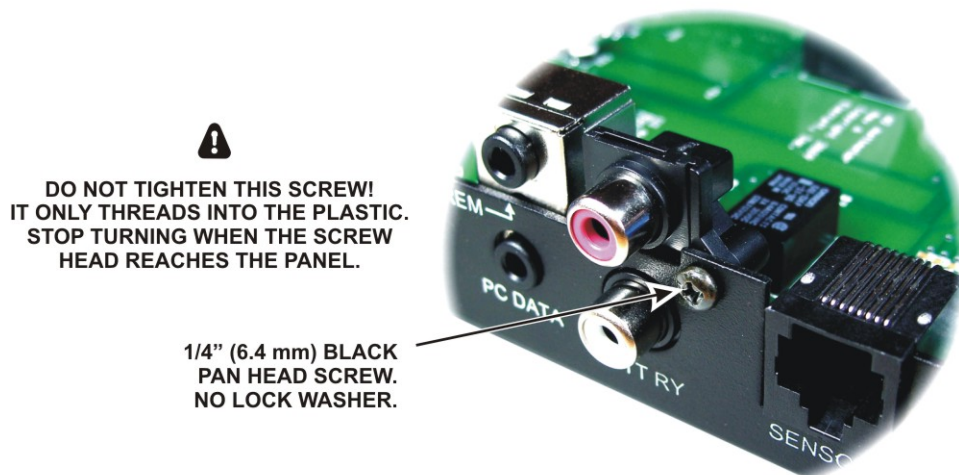

Figure 8. Installing PTT RY Connector Screw.

Locate the front panel cover and remove the paint from around the screw holes on the *inside surface* to it will make good contact with the other case parts (see Figure 9).

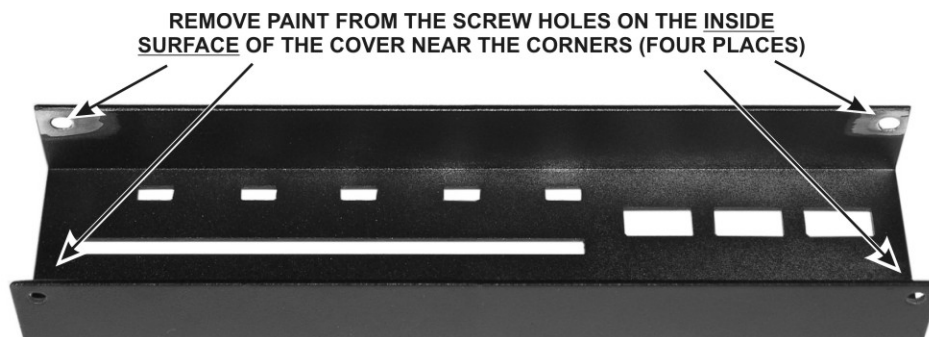

Figure 9. Preparing Front Panel Cover for Mounting

Fit the front panel cover over the LEDs so the holes on the bottom line up with the remaining open holes in the bottom 2D fasteners. Check the adjacent LEDs carefully to ensure they are all aligned in even rows. If needed, *gently* adjust their position for best alignment. This is best done with the cover off.

Secure front panel cover to the 2D fasteners with two 3/16" (4.0 mm) black pan head screws.

- Mount 2D fasteners with 3/16" (4.0 mm) black pan head screws at each end of the rear panel cover as shown in Figure 10 (A). Install one fastener at each end of the panel. Do not use lock washers.
- Mount 2D fasteners with 3/16" (4.0 mm) black flat head screws at each end of the front panel cover as shown in Figure 10 (B). Install one fastener at each end of the panel. Do not use lock washers.

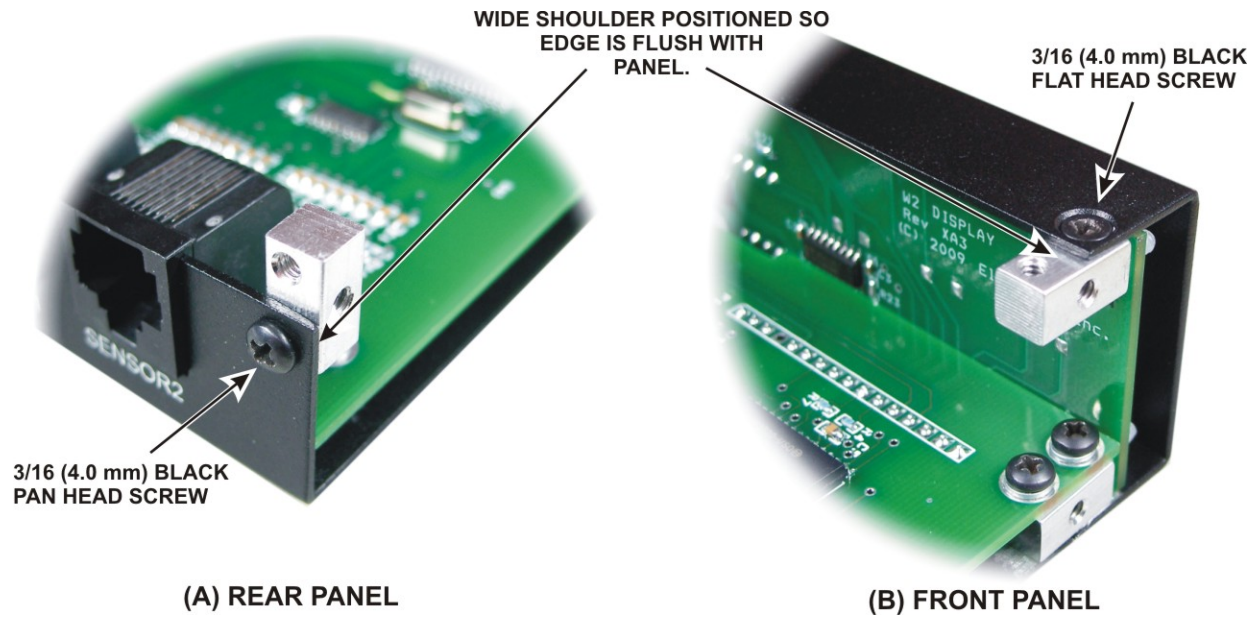

Figure 10. Mounting Front and Rear Panel 2D Fasteners.

- Clean the paint from around the holes on the inside (flat) side of the side panels as needed to ensure good electrical contact with the 2D fasteners when they are mounted. Note that there is a left and a right side panel. They are *not* interchangeable because of the beveled holes for flat-head mounting screws. **Be sure to scrape the paint only from the flat, inside surfaces as shown in Figure 11.**

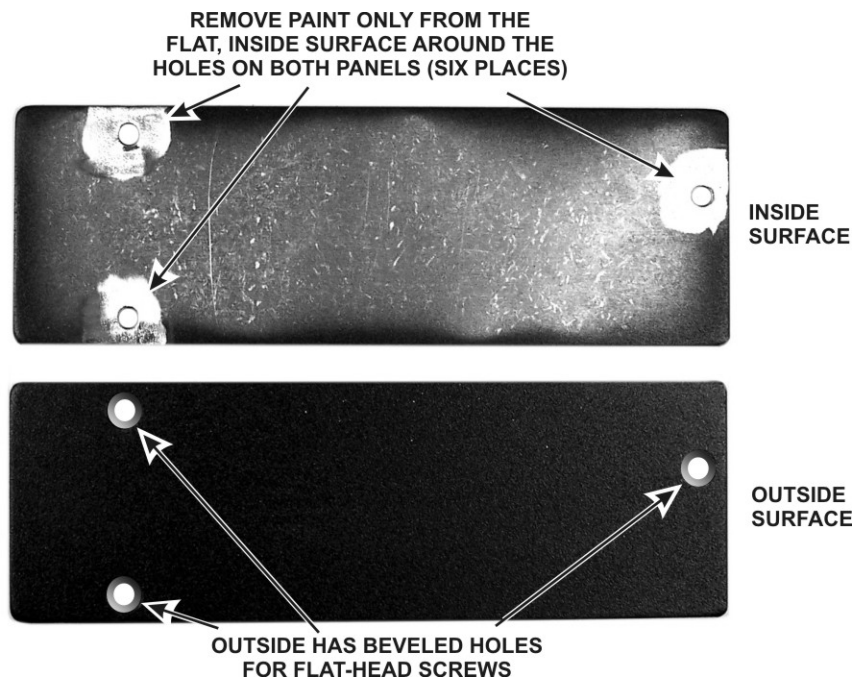

Figure 11. Preparing the Side Panels for Mounting.

Mount both side panels on the W2 display unit using three 3/16" (4.0 mm) black flat head screws in each panel. Do not use lock washers. Start all the screws in each side panel before tightening them to make fitting the panels easier.

Make a final check of the screw securing U3 on the main pc board with the screw that runs through the bottom cover. Be sure the nut is tight against the board.

**NOTE**

**The RJ45 connector, J3, on the main pc board inside the W2 is used only for initial programming of the board at the factory. That's why it's hidden inside the W2.**

Clean the paint from around the four holes on the *inside surface* of the top cover just as you did for the other covers.

Mount the top cover, sliding it on from the rear so the REM connector fits through the hole in the back. Secure the cover with six 3/16" (4.0 mm) black flat head screws, four on the bottom and two at the back. Do not use lock washers.

Mount the four self-stick feet on the bottom cover as shown in Figure 12. Take care not to bridge the seam between the bottom and front panel.

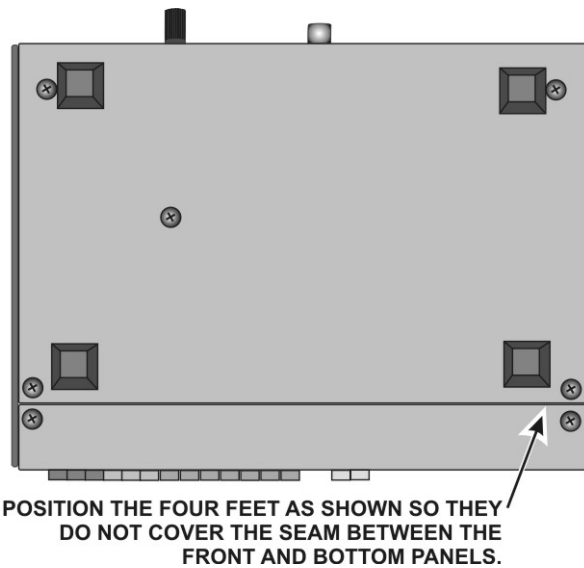

Figure 12. Mounting the Feet on the Bottom Cover.

Make a final check of all the external case screws to ensure they are tight, **except for the screw at the rear panel PTT RY connectors shown in Figure 8 on page 13.**

That completes the assembly of your W2 Display Unit.

## *Directional Coupler*

The directional coupler sensor used to provide RF Power and SWR a measurement is furnished completely assembled and tested to ensure the greatest measurement accuracy. We recommend you do not open the unit. The interior of a typical directional coupler is shown in Figure 13.

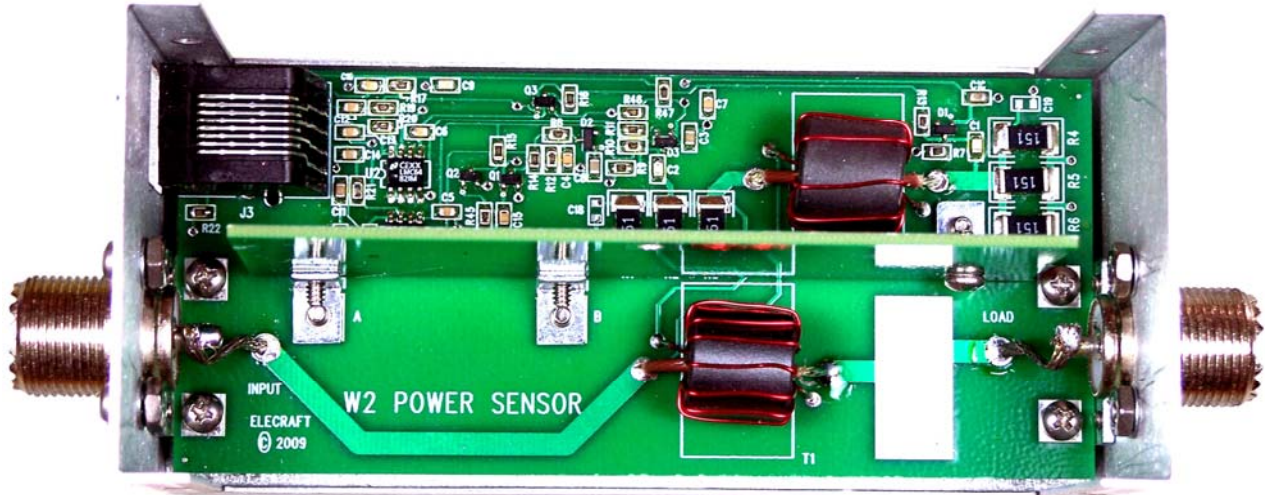
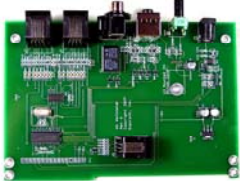



Figure 13. Typical Directional Coupler Sensor Interior View.



# Appendix A Parts List







## W2 Circuit Boards

ILLUSTRATION	DESCRIPTION	QTY.	ELECRAFT PART NO.
	W2 Main PCB Assembly	1	E850353
	W2 Front Panel (FP) PCB Assembly	1	E850354

## Enclosure



ILLUSTRATION	DESCRIPTION	QTY.	ELECRAFT PART NO.
	Front Panel	1	E100340
	Bottom Cover	1	E100342
	Right Side Panel	1	E100344
	Left Side Panel	1	E100343
	Top Cover	1	E100341

W2 Hardware (E850356)

ILLUSTRATION	DESCRIPTION	QTY.	ELECRAFT PART NO.
	2-D Fastener	6	E100078
	4-40, Lock washer, #4, Split Z	7	E700004
	4-40, Screw, 1/4" (6.4 mm), Black, Pan Head	1	E700009
	4-40, Screw, 3/16" (4.0 mm), Black, Pan Head	16	E700015
	4-40, Screw, 1/2" (13 mm), Black, Pan Head	1	E700030
	4-40, Screw, 3/16" (4.0 mm), Black, Flat Head	10	E700025
	4-40, Nut, Hex, Zinc	1	E700011
	2-56, Screw, 1/4" (6.4 mm) ,Pan Head ,Nylon,	2	E700147
	4-40, Standoff, Round 1/4" (6.4 mm)	2	E700026
	#4, Spacer, Round, 1/8" (3.2 mm)	1	E700140
	1/2 X 1/2 (13 mm X 13 mm), Rubber Foot, Self-Adhesive	4	E700024
	Keycap Gray	3	E980027

## Cables

These cables are provided with both the factory-assembled and kit versions of the W2.

ILLUSTRATION	DESCRIPTION	QTY.	ELECRAFT PART NO.
	Power Cable (An RCA connector is included for use with rigs such as the K3 that have a female RCA power jack for accessories)	1	E850361
	Sensor Cable (this cable may be packaged with each sensor)	1 per Sensor	E850368
	W2 Serial Cable Assembly	1	E850369

## Sensors

ILLUSTRATION	DESCRIPTION	QTY.	ELECRAFT PART NO.
	Directional Coupler 1.8-54 MHz 200 W	See note	E850364
	Directional Coupler 1.8-54 MHz 2KW		E850365
	Directional Coupler 144-450 MHz 200 W		E850370

**Note:** Up to two sensors may be connected to one display unit.

# Appendix B – Schematic Diagrams

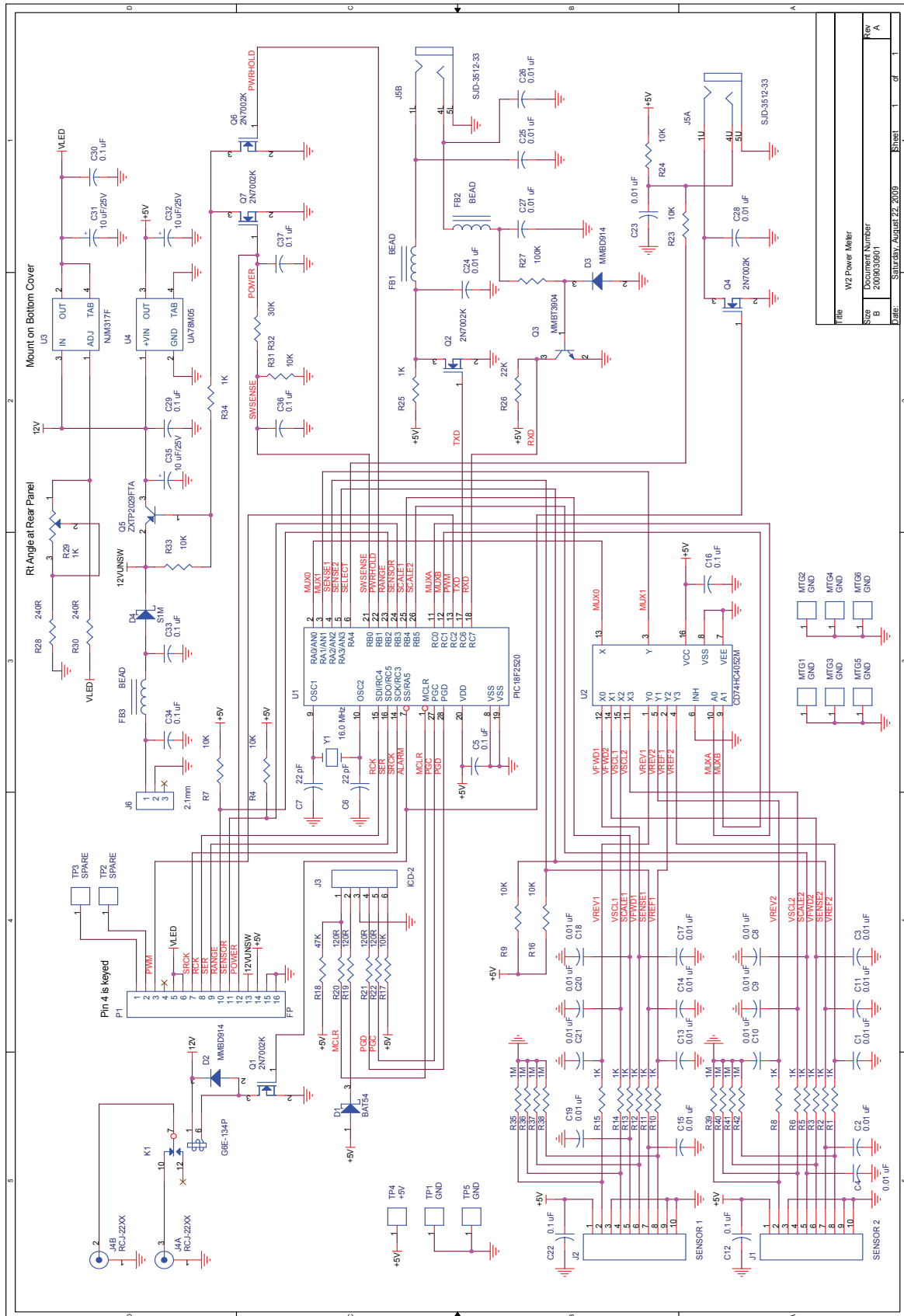

File	VZ Power Meter
Size	Document Number
B	2009030901
Date	Saturday, August 22, 2009
	Sheet 1 of 1
Rev	A

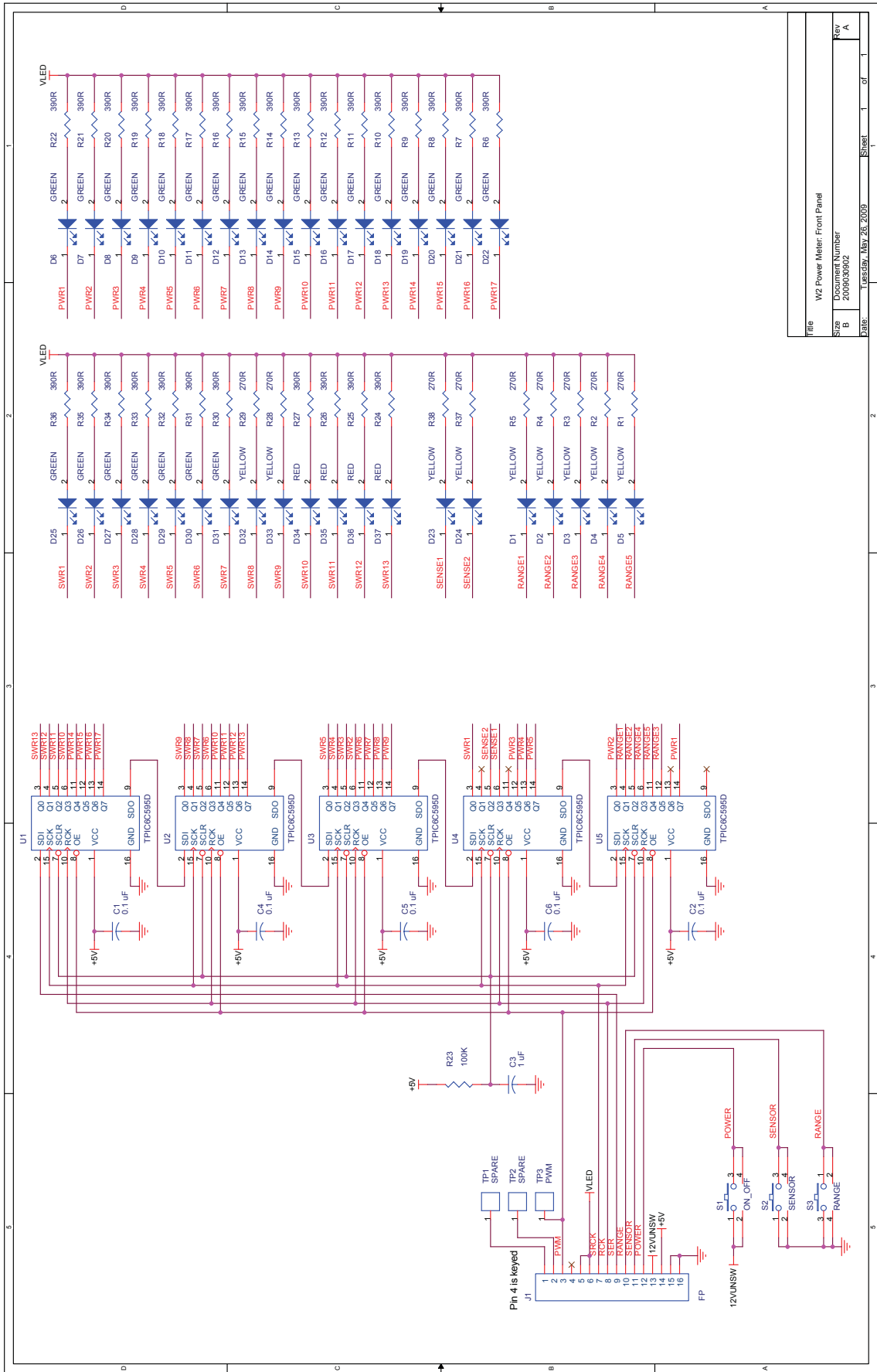

File	W2 Power Meter: Front Panel
Size	Document Number
B	2009032902
Date:	Thursday, May 26, 2009
Sheet	1 of 1

# LOW POWER SENSOR

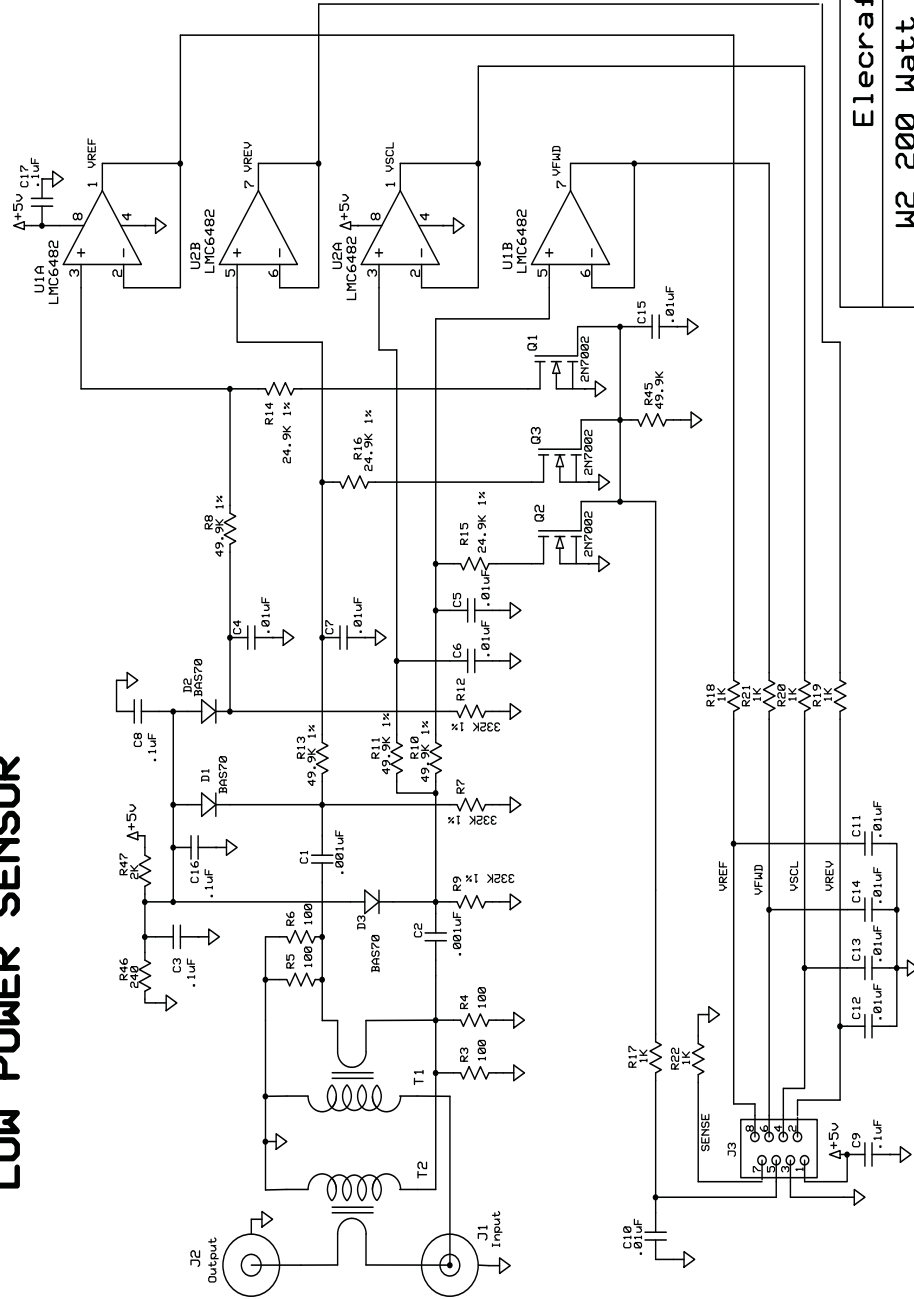

Elecraft

W2 200 Watt HF Sensor

Bob Friess

Rev 1.0

3/21/09

Page 1 of 1

# YHF/UHF LOW POWER SENSOR

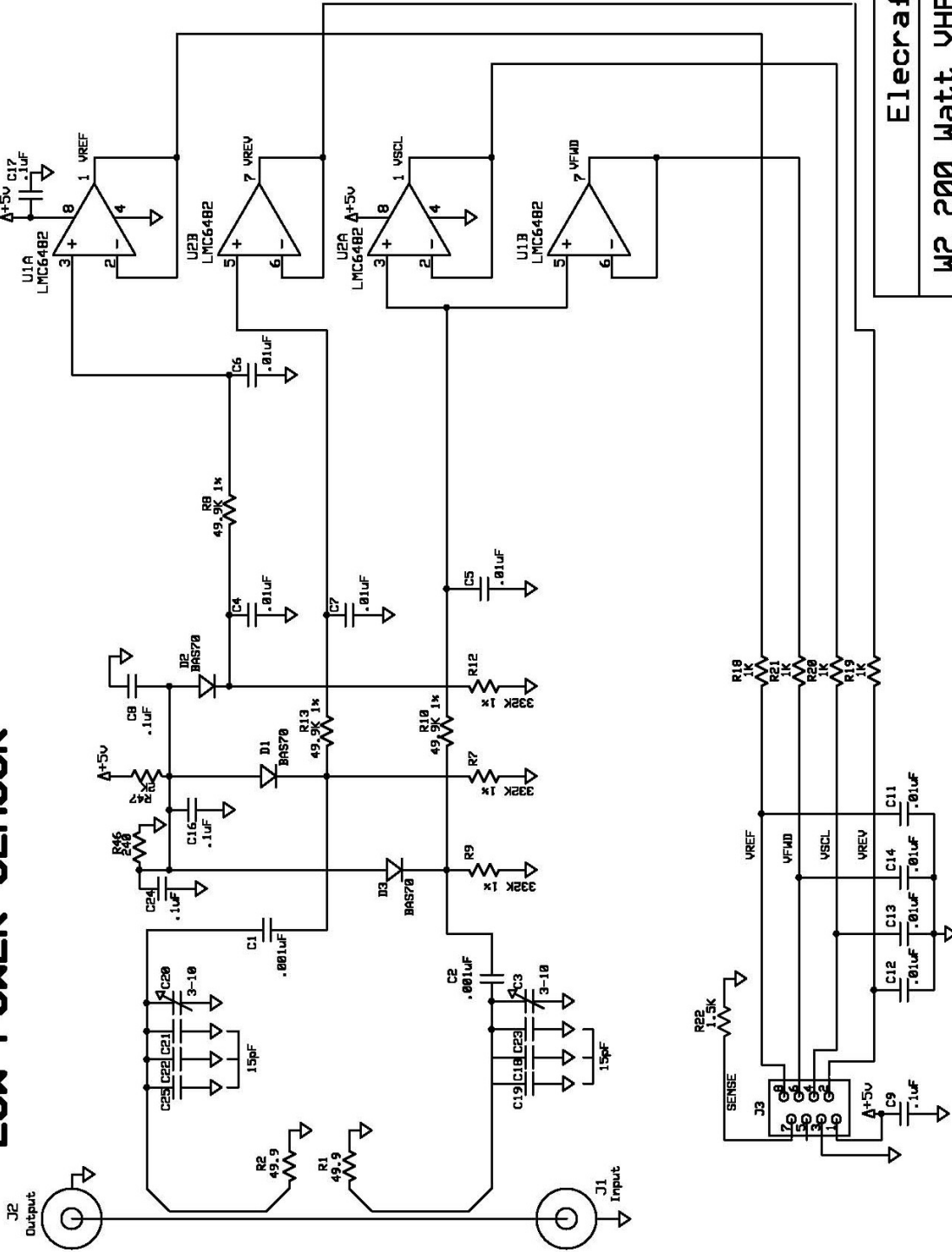

Elecraft

W2 200 Watt YHF/UHF Sensor

Page 1 of 1

Rev A

9/28/09

Bob Friess

# HIGH POWER HF SENSOR

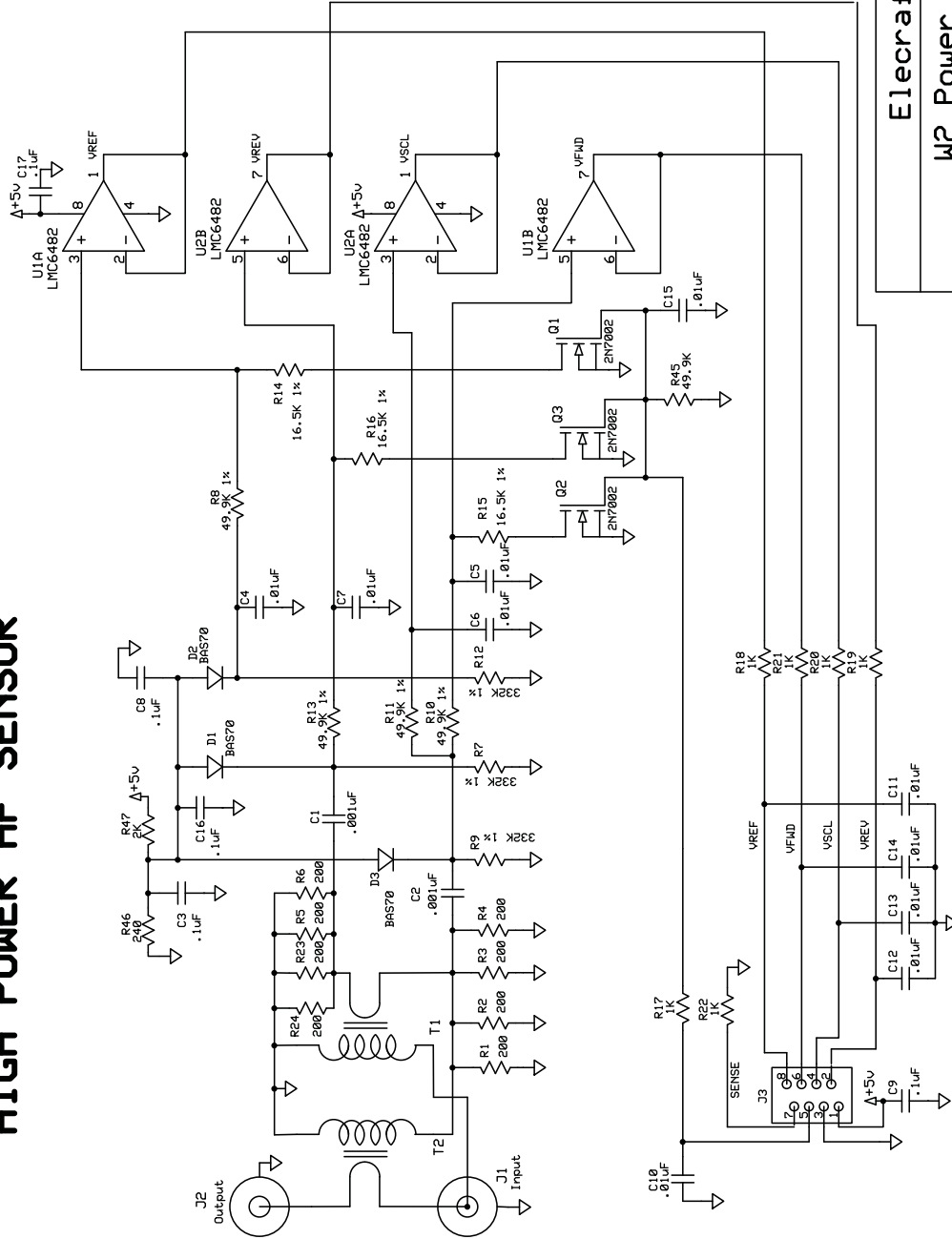

Elecraft

W2 Power Meter

Bob Friess  
 Rev 1.0  
 3/21/09  
 Page 1 of 1



# SERIAL INTERFACE CABLE

